

|

2024 12 06

52

4661.30  
2913.35

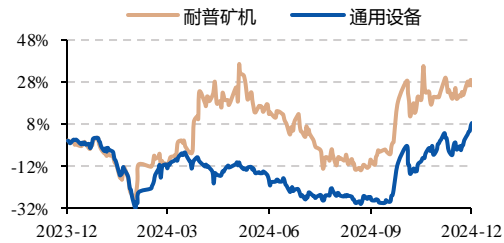

%	1M	3M	12M
	4.39	39.12	32.75
	10.43	48.76	9.02

:S0530524100001  
hejianhong@hncasing.com

1	2024	2024-10-25
2	(300818.SZ)2024	2024-08-20
3	(300818.SZ)2023	2024-04-02

	2022A	2023A	2024E	2025E	2026E
( )	748.53	937.76	1,233.85	1,558.26	1,873.72
( )	134.33	80.07	155.53	205.09	258.95
	0.85	0.51	0.98	1.30	1.64
	7.33	7.80	8.63	9.73	11.12
P/E	34.70	58.21	29.97	22.73	18.00
P/B	4.02	3.78	3.42	3.03	2.65

iFinD

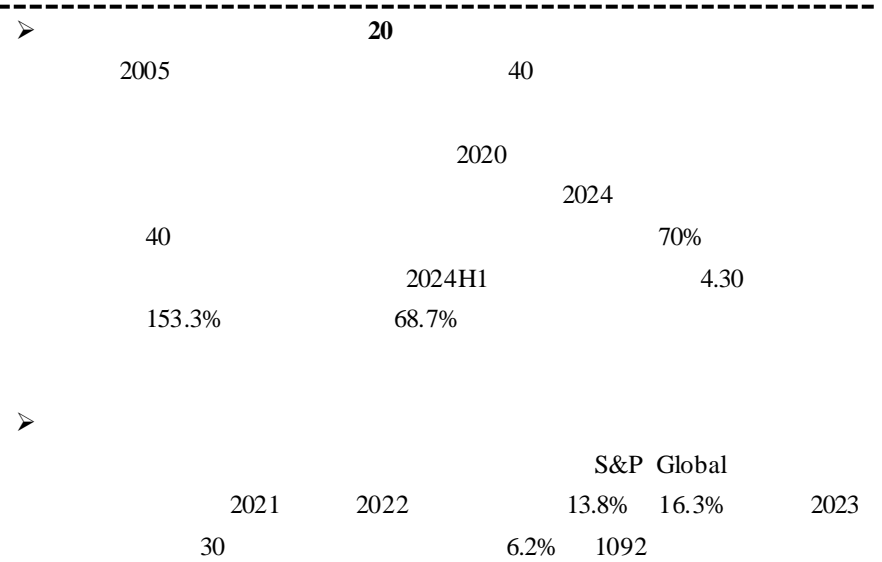

	2021	2022	13.8%	16.3%	2023
30			6.2%	1092	2015
	1993	0.81%	0.6%		
	1993	1.36%	1.12%		
	2005	1.0%	2023		
		0.64%			
					21
	2000	5000	/		2023
	22061	/			

➤



2026

96.41

4 150%



2024-2026

			12.34	15.58	18.74			1.56
2.05	2.59		EPS		0.98	1.30	1.64	2024
12	6		PE		29.97	22.73	18.00	2025
	29X	PE			37.62			



<b>1</b>	<b>20</b>	<b>..... 5</b>
1.1		..... 5
1.2		..... 7
1.3		..... 10
<b>2</b>		<b>..... 11</b>
2.1		..... 11
2.2		..... 16
<b>3</b>		<b>..... 18</b>
3.1		..... 18
3.2		..... 21
3.3		..... 25
<b>4</b>		<b>..... 28</b>
4.1		

---

26	.....	18
27	.....	19
28	.....	20
29	.....	20
30	.....	21
31	.....	22
32	.....	22
33	.....	24
34	.....	25
35	2024 3 .....	27
36	.....	28
1	.....	15
2	.....	16
3	.....	22
4	.....	23
5	.....	24
6	.....	24
7	.....	26
8	.....	27
9	.....	29

1

20

1.1

153,155,013

2005 10 14

20

2005

2020

2024

40

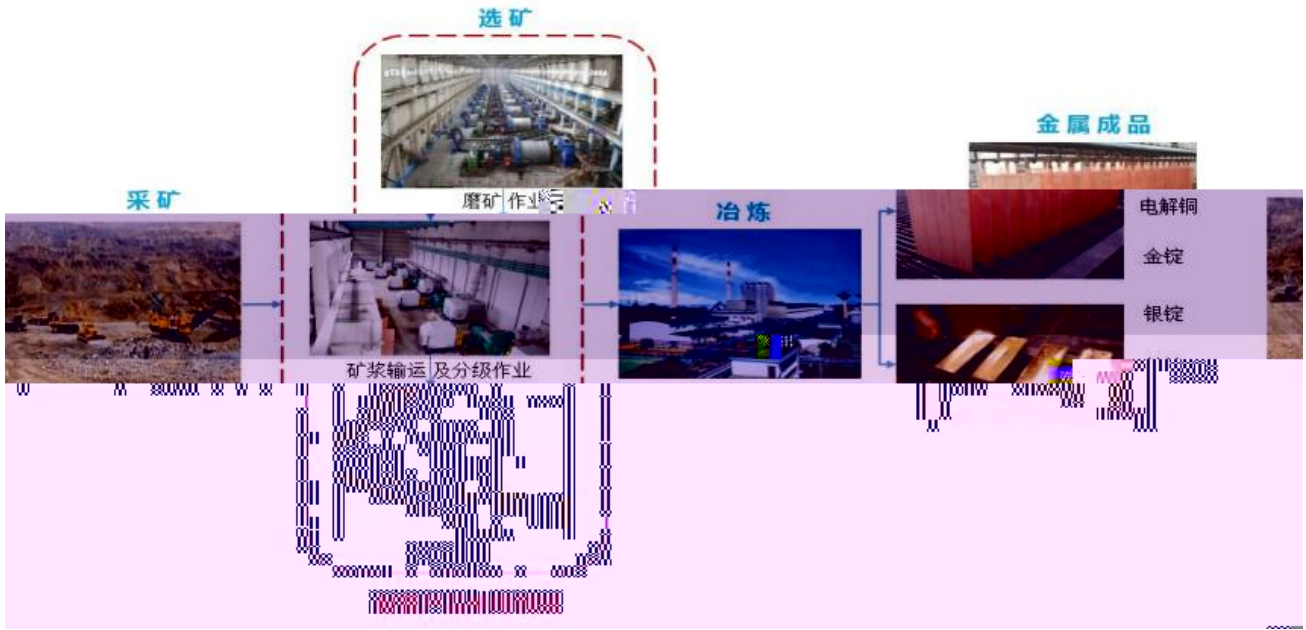

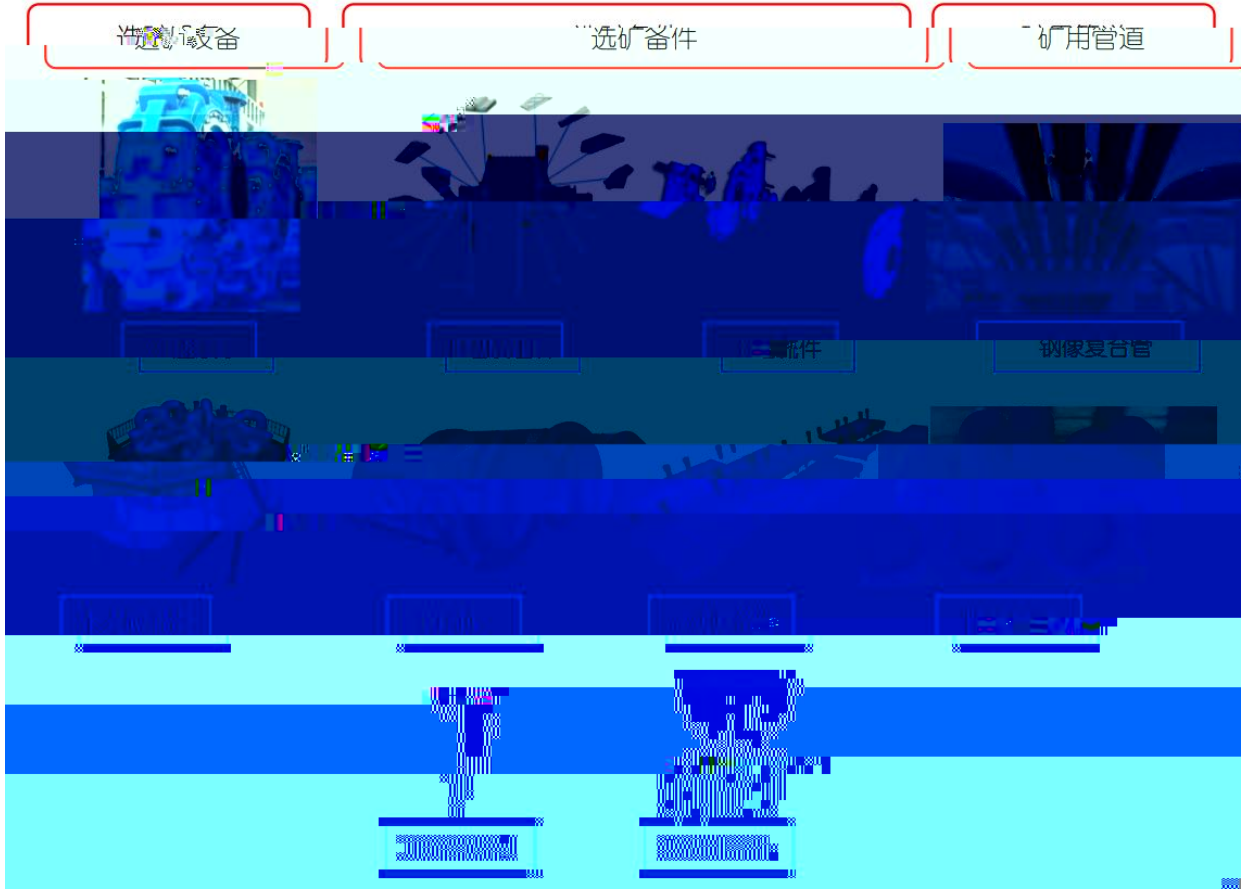

70%                      8%                      4%-5%

4

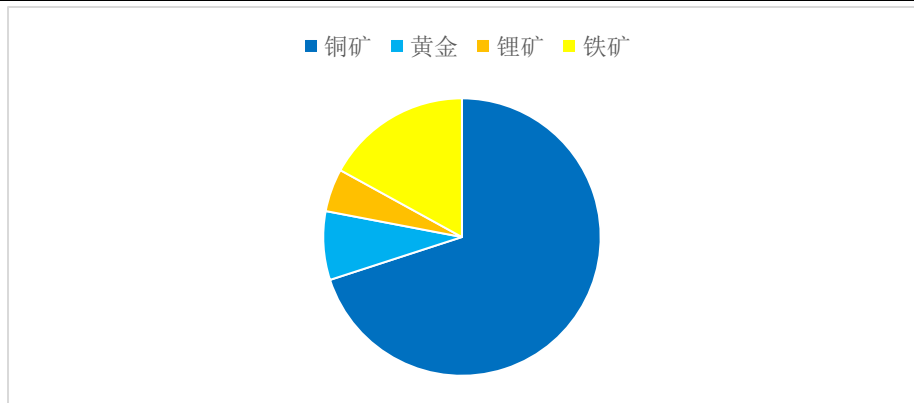

1.2

	EPC	2019-2023	2019-2023	CAGR	2019
3.49	2023	9.38	2020	0.41	28.04%

2021	1.84	2021	10.53
1.84	2021	EPC	2022
8	2022	1.60	EPC 2022
		2021	6.83
		2022	59.15%
	2024	9.21	41.71%
1.20	48.78%	1.17	70.90%
<b>5</b>		<b>6</b>	

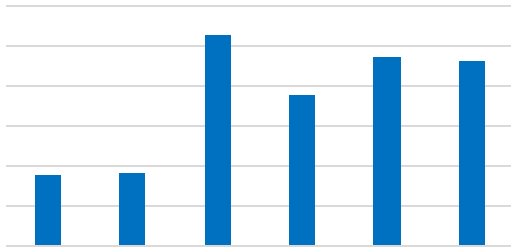

Wind

10-20%	2021	2020	30-35%
EPC	EPC	EPC	
2022	0.89	2023	

Wind

2021	EPC	23
2024	Q1-Q3	
2024Q1-Q3	20.46%	1.23pct
5.62%	-0.38pct	10.94%
+2.59pct	2.74%	-2.82pct
		1.16%

7

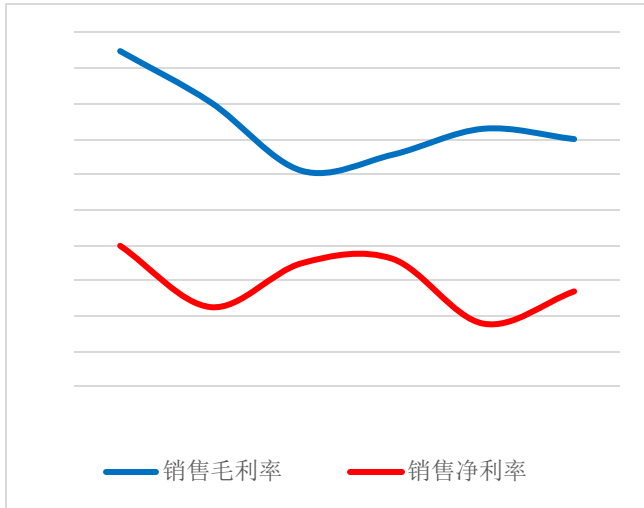

Wind

8

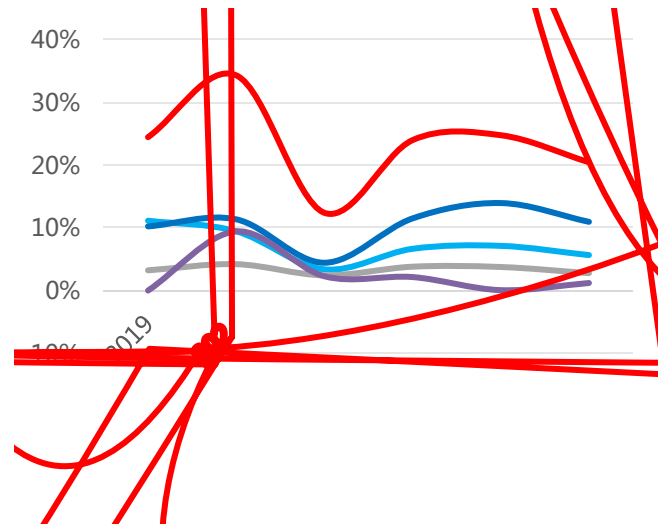

Wind

	EPC		2021		60%	
2019-2020	2.43	2.40	2023	5.42	2024H1	
	3.0			2024		
	5.1	34.88%		5		
		2024H1		42.49%		
	28.01%					

9

10

Wind

153.3%      68.7%

Wind

2024H1      4.30

---

	2021	EPC	EPC	2024
	37.14%	6.86pct		
<b>11</b>				<b>12</b>

---



---

<i>Wind</i>			<i>Wind</i>				
	<b>1.3</b>			<b>50.03%</b>	2024	11	30
				50.03%	5.36%		
					1983		
						2005	
		2011					
		2005			40		
					2022	8	
			2022				
	10		5.00 /		1,500,060		
	2.14%		48				40%
30%	30%						

---

实控人：郑昊

50.03%

1.07%

1.22%

1.21%

41.11%

江西耐普矿冶股份有限公司

Wind

Global

2021

2022

13.8%

16.3%

30

6.2%

1092

2013

1457

365

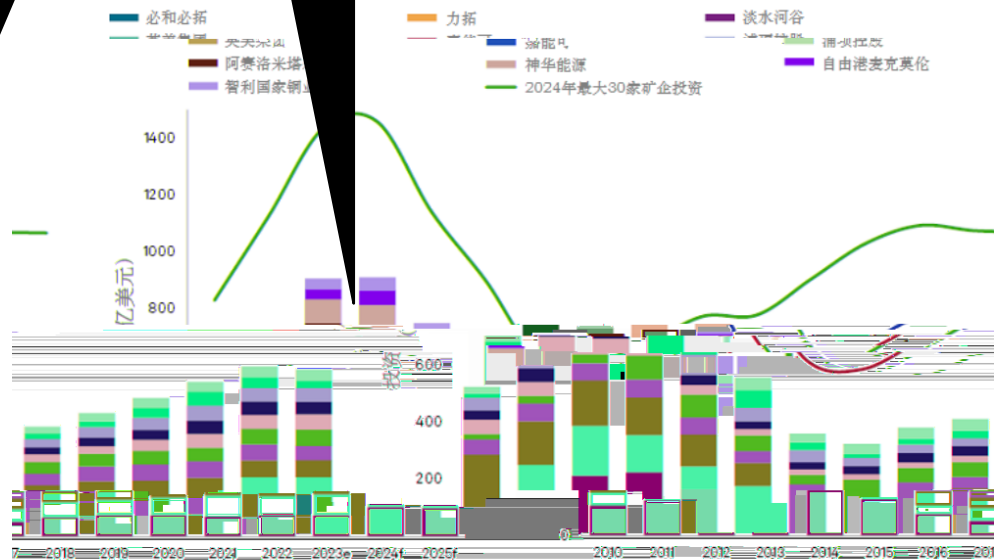

截止日期: 2023年9月1日

投资: 总文出; E: 估计; F: 预测

注: 必和必拓和力拓权益归属由截至到6月30日; 资料来源: 财信证券

S&P Global

2015

21% 2023

31

15 10

主要发现目前资源量 (亿吨)

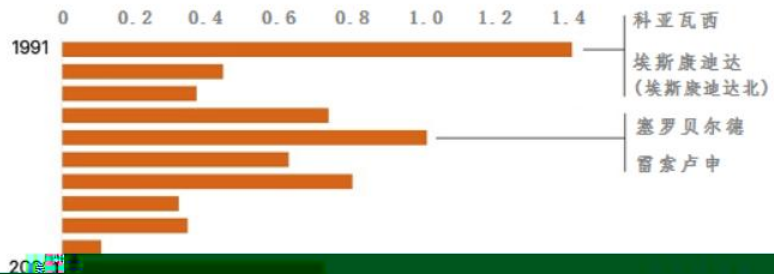

S&P Global

**Cochilco**

2013-2015

0.77-0.78

2023

0.64

USGS

2023

10

1.9

1

1.2

0.8

0.53

0.5

2023

2200

500

0.5% 533

2008

Cochilco

2023

8.4% 142

25

Codelco

2023

50.72

10%

16%

16

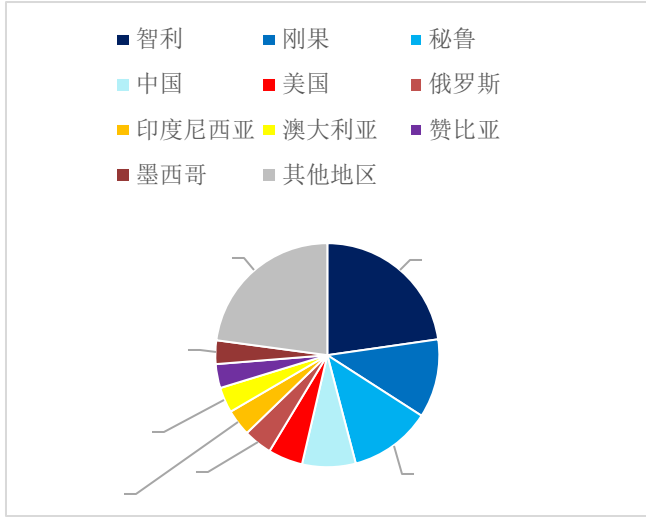

SMM

17

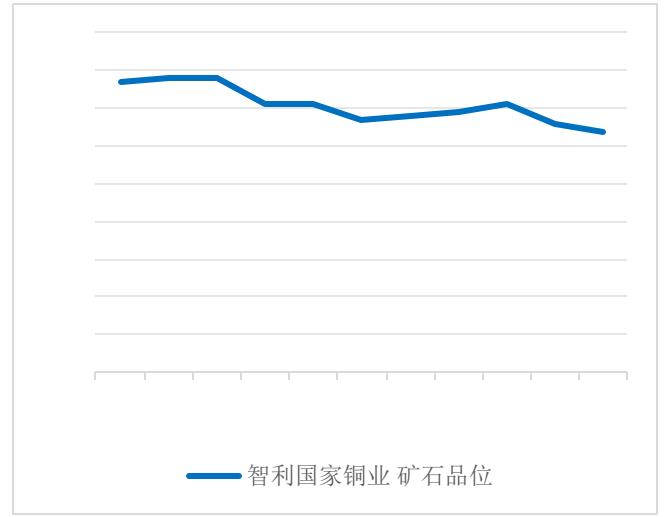

iFind

Codelco

			1993	0.81%	0.6%	
1993	1.36%	1.12%				2005
1.0%	2023	0.64%				
			2000	5000	/	
						21
					2023	22061
						2022
2005	2.34					

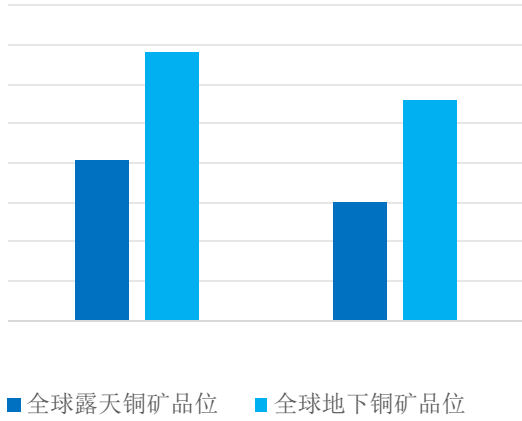

ICSG 2014 2014-2018 85%  
 2023 80%  
 20

<i>iFinD</i>		<i>ICSG</i>	
SMM			
		400	200
42%	18%	21%	
			32.3% 26.1%
23.4%	18.9%	35.7%	63.9%
		69.8%	26.3% 33.6% 41.2%
41.7%	28.6%	22%	55%

2,500

21

**1**

		%		%		%
23269	32.3	486.4	26.3	14502	63.7	
16400	26.1	1008	33.6	2430	71.1	
1850	23.4	104.2	41.2	84.2	49.7	
53	18.9	1.14	41.7	1.4	50	
67800	35.7	631	28.6	1400	73.7	
2976	33.4	261.4	55.5	572.8	56.1	
5200	26	607	45	856.6	62.6	
307	63.9	5.95	22	23.6	85	
2582	69.8	18.99	55	26	64	
112.2	16.3	1.4	62	1.4	72	

**10**

			2015	2019
			150	2020
	2020	177.90	2023	318
1-10			1894.5	2024
4.3%				

---

*iFind*

2.2

2

---

---

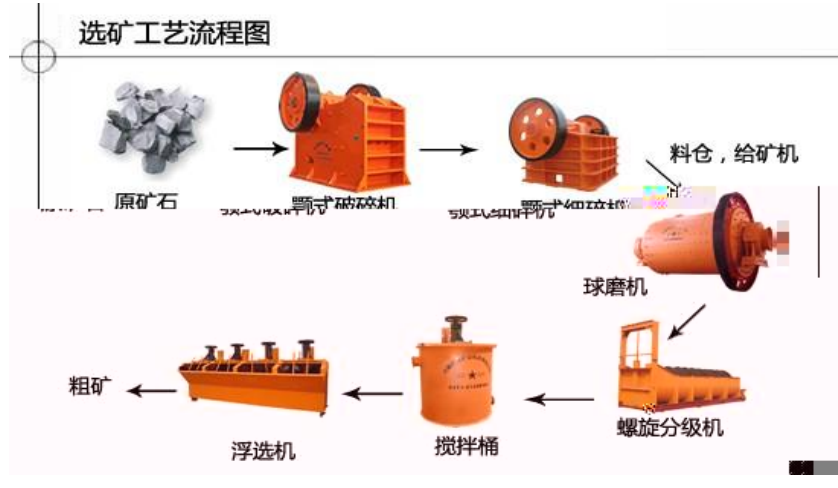

				2022		X	
				0.311			-10mm
25%	0.400%	+10mm	75%	0.281%		+10mm	
			56.85%			0.540%	
1.92	82.82%		0.085%				
0.479%			0.198%				

23

24

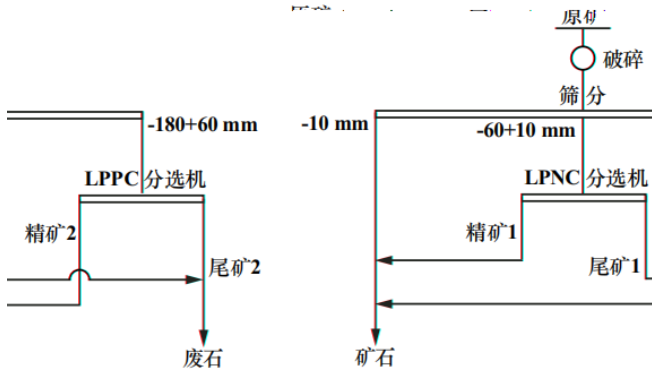

X

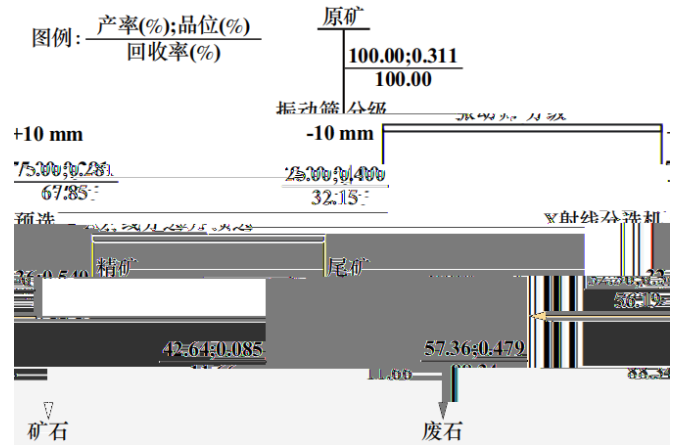

X





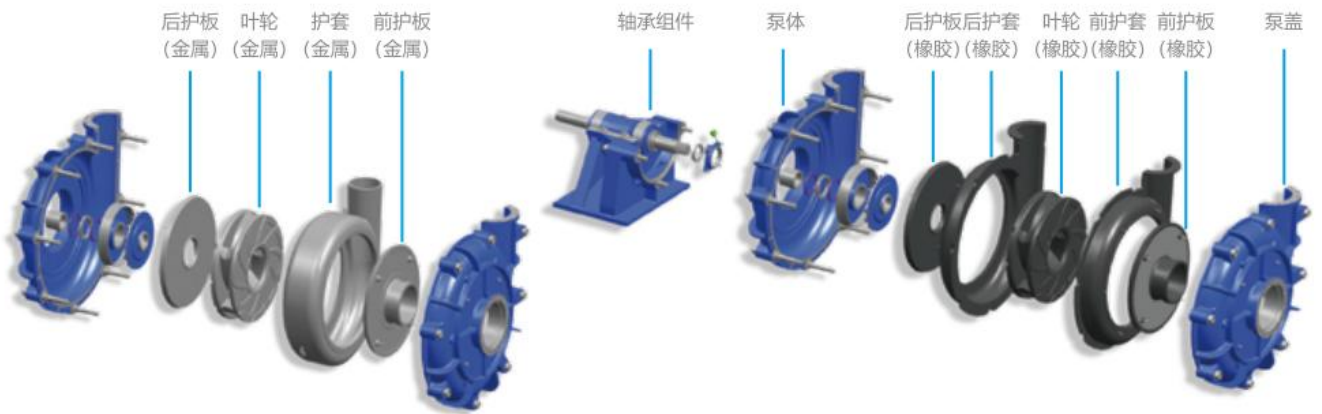
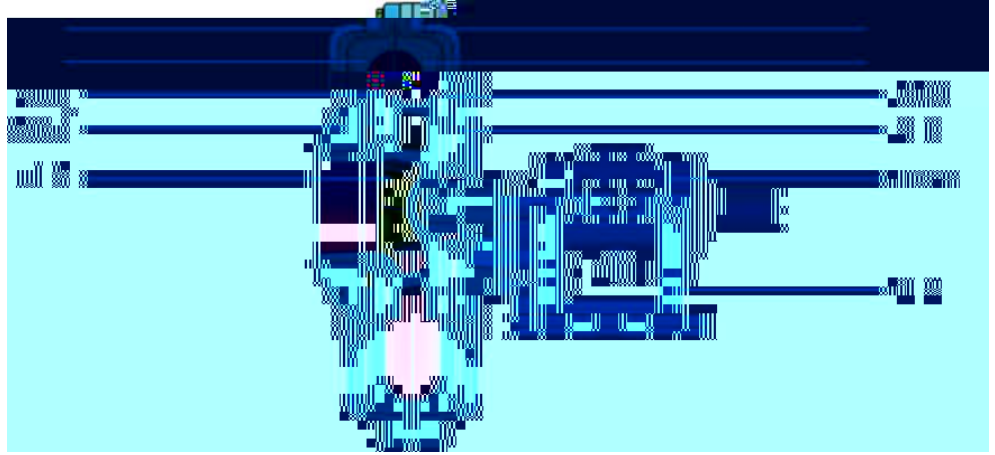

单体结构

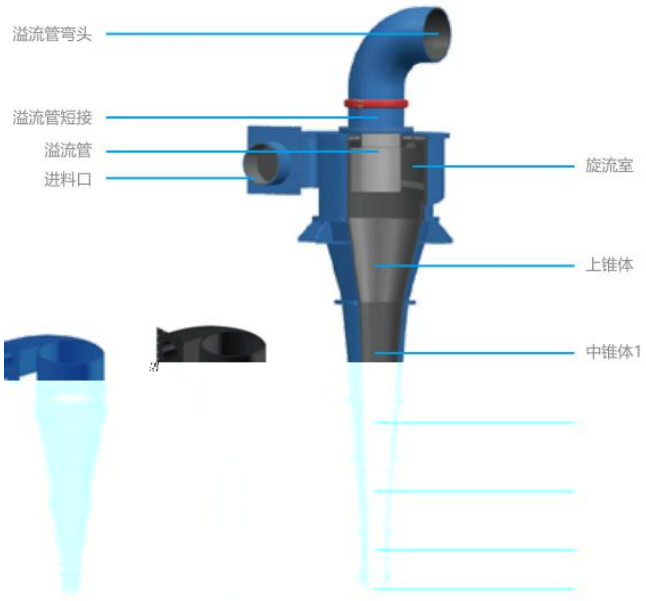

		2024		750mm
650mm		838-7		
		7.32	13m	7.9 14.3m
		12.2	11m	7.9 13.6m

3.2



0.9% 1.5% Si 0.3% 1.0% Mn 10%  
15% Ak 150J/cm2  
6 1  
1921

SAB

105

12

36

9-12

4.90kWh/t

4

			dB	/	kg/t	kWh/t
180	60	97-100	76	0.66	5.08	
285	48	88	40	0.64	4.9	

SAB

0.27 /t

105 t

28

5

T/D

	13.67	14.06	15.81	19.11	24.16
/			3.99		
	54.56	56.12	63.10	76.23	96.41

Wind

### 3.3

100.00% 2023      192.50%      4      10      /      10      /

### 34

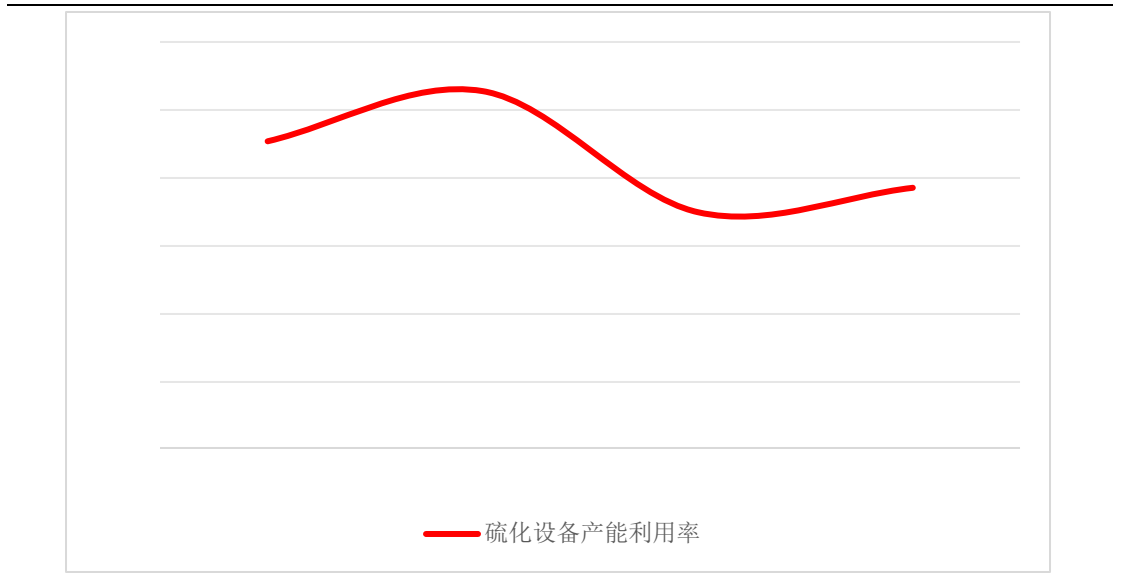

100.00%

2022      2023

100.00%

2023

2

100%

1-2

7

7					
			7243.71	6944.32	95.87%
	/		823	836	101.60%
2021			/	25010	/
			1885	2020	107.16%
	m2		1530.45	1530.45	100.00%
			11496.93	10847.89	94.35%
	/		1053	906	86.07%
2022			/	25912	/
			697	2067	296.56%
	m2		1983.94	1983.94	100.00%
			14568.34	12347.67	84.76%
	/		993	1132	114.00%
2023			/	27239	/
			1196	3302	276.09%
	m2		/	/	/

2022

2024 3

1%

2023 10

3,000.00



Hudbay  
HUDBAY  
20 50 EPC  
*Hudbay*

36

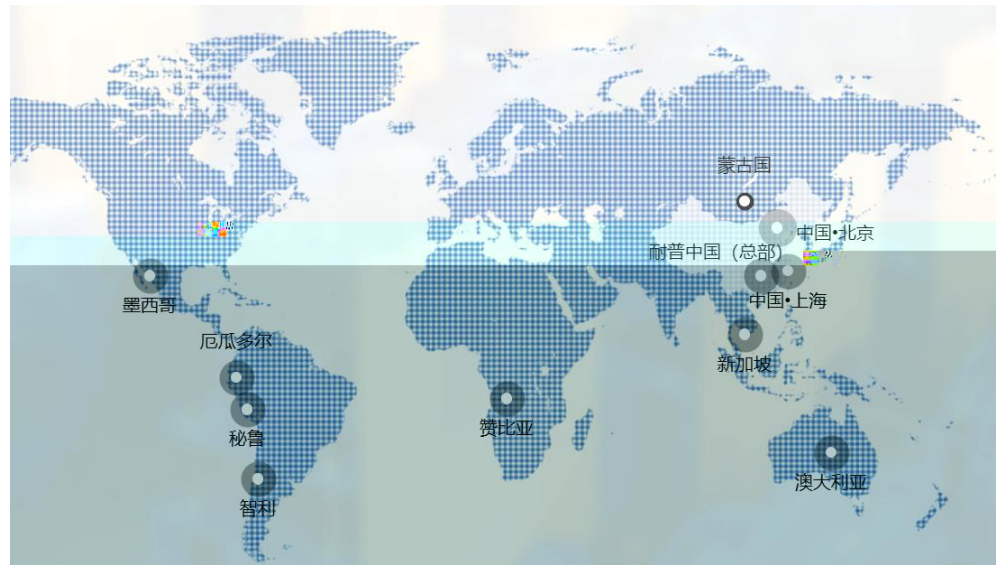

4

4.1

1

			2024-2026				34%	31%	35%
			43.9%	44.0%	44.2%				
<b>2</b>									
						2024-2026			
	3.5%	20%	22%		26.8%	26.7%	26.7%		
<b>3</b>									
							2024-2026		32% 22% 14%
			23.5%						
<b>4</b>									
					2024-2026		25%	20%	15





	2022A	2023A	2024E	2025E	2026E		2022A	2023A	2024E	2025E	2026E
	748.53	937.76	1,233.85	1,558.26	1,873.72		748.53	937.76	1,233.85	1,558.26	1,873.72
:	503.10	5595.86	779.84	977.59	1,165.93	(%)	-28.92	25.28	31.57	26.29	20.24
	7.87	7.23	9.25	10.91	12.55		134.33	80.07	155.53	205.09	258.95
	49.66	66.54	83.28	103.62	122.73	(%)	-27.06	-40.39	94.24	31.86	26.26
	85.99	130.76	134.49	169.07	202.36	(EPS)	0.85	0.51	0.98	1.30	

6 12 /

		300 15%
		300 5% 15%
		300 -10% 5%
		300 10%
		300 5%
		300 -5% 5%
		300 5%

"